

Data sheet | Item number: 790-400

Busbar carrier; for busbars Cu 10 mm x 3 mm; no contact to DIN rail; insulated

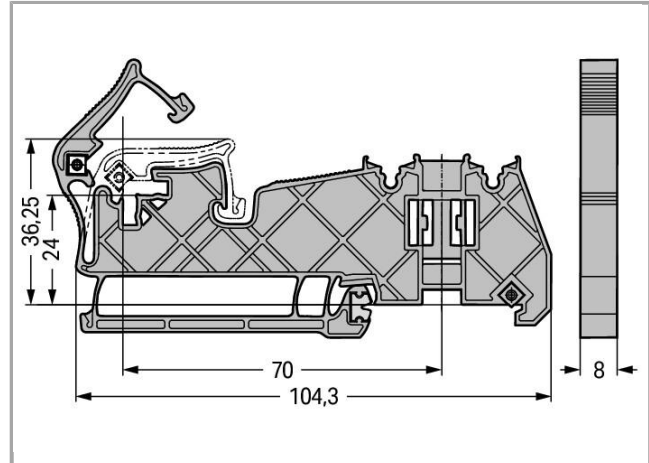

790-400

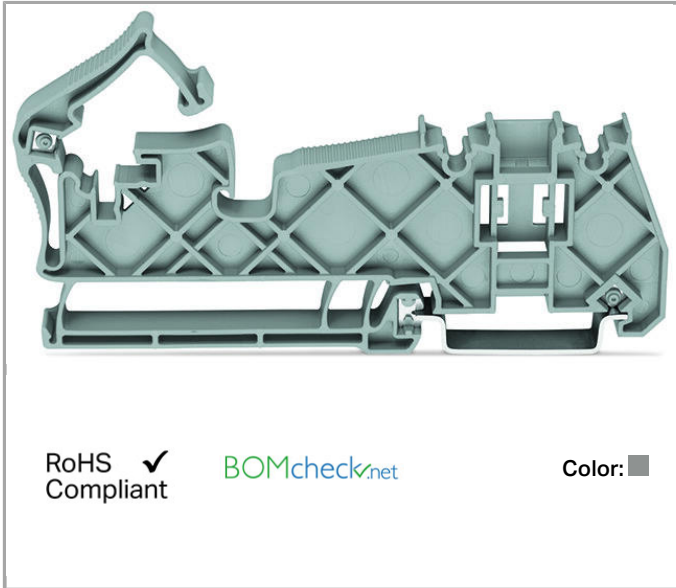

Data

Technical Data

Main product function

Shield termination

Material Data

Weight

10.969 g

Commercial data

Product Group

2 (Terminal Block Accessories)

Country of origin

DE

GTIN

4050821087717

Customs Tariff No.

39269097900

Compatible products

General accessories



















Item no.: 2002-121
Adaptor















2002-121



Item no.: 2009-163
Group marker carrier

2009-163

	Item no.: 249-118 Group marker carrier	249-118
	Item no.: 249-119 Group marker carrier	249-119
	Item no.: 249-120 Group marker carrier	249-120
Marking accessories		
	Item no.: 2009-110 Marking strips; on reel; not stretchable; plain; snap-on type	2009-110
	Item no.: 2009-115 WMB-Inline; for Smart Printer; on reel; stretchable 5 - 5.2 mm; plain; snap-on type	2009-115
	Item no.: 2009-115/000-002 WMB-Inline; for Smart Printer; on reel; stretchable 5 - 5.2 mm; plain; snap-on type	2009-115 /000-002
	Item no.: 2009-115/000-006 WMB-Inline; for smartPRINTER; on reel; stretchable 5 - 5.2 mm; plain; snap-on type	2009-115 /000-006
	Item no.: 2009-115/000-007 WMB-Inline; for Smart Printer; on reel; stretchable 5 - 5.2 mm; plain; snap-on type	2009-115 /000-007
	Item no.: 2009-115/000-012 WMB-Inline; for smartPRINTER; on reel; stretchable 5 - 5.2 mm; plain; snap-on type	2009-115 /000-012
	Item no.: 2009-115/000-017 WMB-Inline; for Smart Printer; on reel; stretchable 5 - 5.2 mm; plain; snap-on type	2009-115 /000-017
	Item no.: 2009-115/000-023 WMB-Inline; for Smart Printer; on reel; stretchable 5 - 5.2 mm; plain; snap-on type	2009-115 /000-023
	Item no.: 2009-115/000-024 WMB-Inline; for smartPRINTER; on reel; stretchable 5 - 5.2 mm; plain; snap-on type	2009-115 /000-024
	Item no.: 2009-135 WMB-Inline; for Smart Printer; on reel; stretchable 5 - 5.2 mm; plain; snap-on type	2009-135
	Item no.: 793-501 WMB marking card; as card; not stretchable; plain; snap-on type	793-501
	Item no.: 793-501/000-002 WMB marking card; as card; not stretchable; plain; snap-on type	793-501 /000-002
	Item no.: 793-501/000-005 WMB marking card; as card; not stretchable; plain; snap-on type	793-501 /000-005

	Item no.: 793-501/000-006 WMB marking card; as card; not stretchable; plain; snap-on type	793-501 /000-006
	Item no.: 793-501/000-007 WMB marking card; as card; not stretchable; plain; snap-on type	793-501 /000-007
	Item no.: 793-501/000-012 WMB marking card; as card; not stretchable; plain; snap-on type	793-501 /000-012
	Item no.: 793-501/000-017 WMB marking card; as card; not stretchable; plain; snap-on type	793-501 /000-017
	Item no.: 793-501/000-023 WMB marking card; as card; not stretchable; plain; snap-on type	793-501 /000-023
	Item no.: 793-501/000-024 WMB marking card; as card; not stretchable; plain; snap-on type	793-501 /000-024
	Item no.: 793-5501 WMB marking card; as card; for terminal block width 5 - 17.5 mm; stretchable 5 - 5.2 mm; plain; snap-on type	793-5501
	Item no.: 793-5501/000-002 WMB marking card; as card; for terminal block width 5 - 17.5 mm; stretchable 5 - 5.2 mm; plain; snap-on type	793-5501 /000-002
	Item no.: 793-5501/000-005 WMB marking card; as card; stretchable 5 - 5.2 mm; plain; snap-on type	793-5501 /000-005
	Item no.: 793-5501/000-006 WMB marking card; as card; stretchable 5 - 5.2 mm; plain; snap-on type	793-5501 /000-006
	Item no.: 793-5501/000-007 WMB marking card; as card; stretchable 5 - 5.2 mm; plain; snap-on type	793-5501 /000-007
	Item no.: 793-5501/000-012 WMB marking card; as card; stretchable 5 - 5.2 mm; plain; snap-on type	793-5501 /000-012
	Item no.: 793-5501/000-014 WMB marking card; as card; stretchable 5 - 5.2 mm; plain; snap-on type	793-5501 /000-014
	Item no.: 793-5501/000-017 WMB marking card; as card; stretchable 5 - 5.2 mm; plain; snap-on type	793-5501 /000-017
	Item no.: 793-5501/000-023 WMB marking card; as card; stretchable 5 - 5.2 mm; plain; snap-on type	793-5501 /000-023



Item no.: 793-5501/000-024
WMB marking card; as card; stretchable 5 - 5.2 mm; plain; snap-on type

793-5501
/000-024

N-busbar



Item no.: 210-133
Busbar; tin-plated; 1000 mm long; Cu 10 mm x 3 mm

210-133



Item no.: 790-134
Busbar; tin-plated; 50 mm long; Cu 10 mm x 3 mm

790-134

Downloads

Documentation

Bid Text

790-400

doc
23.0 kB

Download

CAD/CAE - Smart Data

CAD data

3D Download 790-400

URL

Download

Subject to changes.